

FLEX 8 Quick Start



- Fully Modular 8 ×8 signal architecture
- Mixed signal matrix switching
- Up to 16 mega pixels output splicing
- Auto switch input
- Load and save up to 256 presets
- Output resolution up to 2048x1152@60Hz / 2560x816@60Hz
- EDID management
- Remote control by XPOSE and RGBlink OpenAPI

CONTENTS

Product Introduction.....	3
In The Box.....	4
Hardware Orientation.....	5
Basic Front Panel.....	5
Matrix Front Panel.....	6
Rear Panel.....	7
Matrix Front Panel Operation.....	8
Software Operation.....	12
Install Software.....	12
Login to the Software.....	15
Connect to Software.....	16
Output Setting.....	19
Operation Mode.....	22
System Settings.....	42
Contact Information.....	46

Product Introduction

FLEX 8 is a matrix capable to distribute any input signal to any output signal through its consistent modular capability to control up to 8 different inputs and 8 different outputs independently. Different devices can be connected in each output and input. It supports HDMI, DVI, SDI, USB and HDBaseT input and output signals, as well as DP output. FLEX 8 features in splitting mode for up to 2K1K, and simple managed by XPOSE software.

System Connection

RGBlink video processing solutions provide a range of flexible configuration options for professional applications.

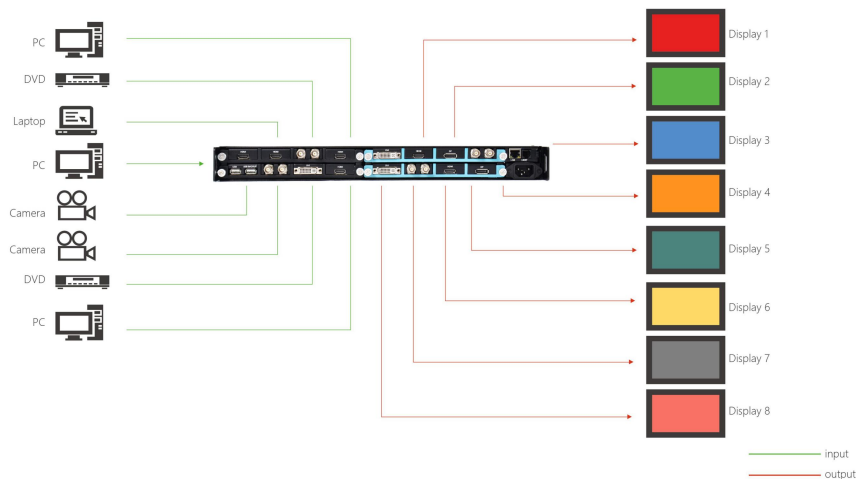

FLEX 8 System Connection Diagram

In The Box

AC Power Cable



Ethernet Cable



HDMI-DVI Cable



Antistatic Bag



DVI To VGA
Connector



DVI To RCA
Connector



USB Disk



Note:





AC Power Cable supplied as standard according to destination market.

Hardware Orientation

Basic Front Panel

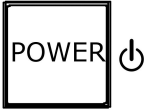
Basic front panel fit for FLEX with splicing feature (with EXT4F-OS installed):







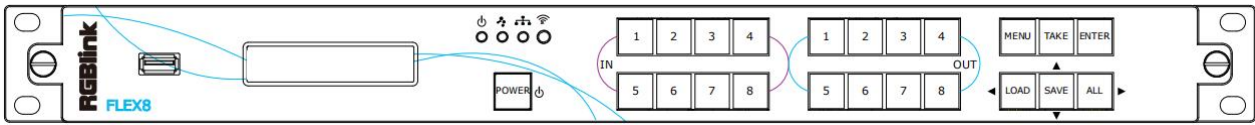



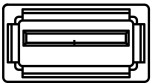
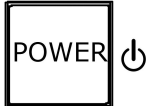

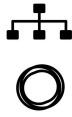

Panel Instruction			
	USB INTERFACE To upgrade the device		POWER BUTTON Turn on/off button. Indicator lights when the device is powered up or in standby state.
	Power Indicator Light up when device power on Keep lighting when device is working		Lan Indicator Lights up when LAN communication occurs
	Serial Port Indicator Lights up when serial communication occurs		Infrared Indicator

Matrix Front Panel

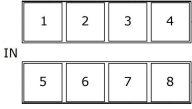
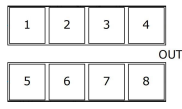

Matrix front panel fit for FLEX 8 with matrix feature (with EXT4F-OM installed)

Panel Instruction			
	USB INTERFACE To upgrade the device		POWER BUTTON Turn on/off button. Indicator lights when the device is powered up or in standby state.
	Power Indicator Light up when device power on Keep lighting when device is working		Lan Indicator Lights up when LAN communication occurs
	Serial Port Indicator Lights up when serial communication occurs		Infrared Indicator
	Menu Button		Take Button, to switch input signals with transition effects
	Button to confirm to enter Menu item		Load Button, to recall the preset from Saved pages
	Save Button, to save current settings to pages.		Choose all inputs or all outputs for matrix mode
	Input signal source selection button under matrix mode		Output signal selection button under matrix mode
	LCD display		

Rear Panel

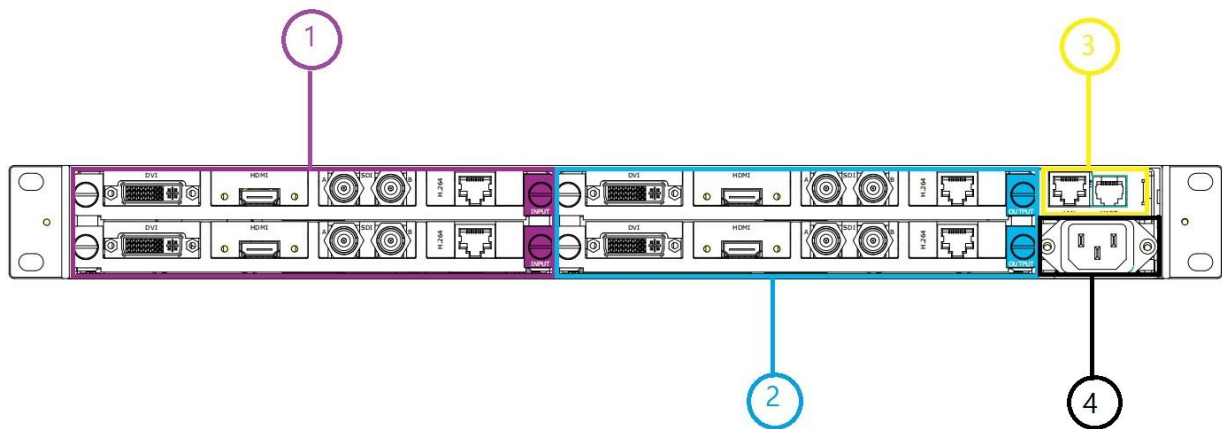

Input Interface

1	<p>Input Card Slots</p> <p>Supports input signals including HDMI, DVI, SDI, USB and HDBaseT.</p>
---	--

Output Interface

2	<p>Output Card Slots</p> <p>Supports output signals including HDMI, DVI, SDI, USB, HDBaseT and DP.</p>
---	--

Control Interface

3	<p>Communication Ports</p> <p>RS232&LAN</p> <p>Connect to XPOSE software</p>
---	--

Power Connection

4	<p>Power Socket-IEC</p>
---	-------------------------

Matrix Front Panel Operation

MENU Operation

Menu Structure

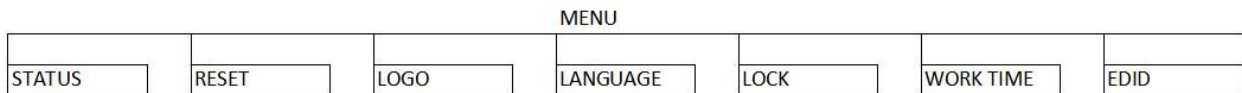



Basic Operation

Press MENU button  and enter the MENU item

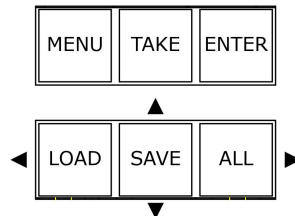

USE the buttons with arrows of up left right down direction to select.



3. Press ENTER  to enter the selected menu item.

STATUS

Shows : the status of each input to output and the LCD screen shows the exact info, as following example In→Out,



And the software version, serial number and IP address of the device.

RESET

To go back to the beginning status, in the RESET item, LCD screens shows instruction as follow

PRESS ANY KEY
PRESS MENU TO EXIT

LOGO

Display logo ON/OFF

LOGO DISP
→ON OFF

LANGUAGE

To switch language between Chinese and English

LANGUAGE/语言
→ENGLISH 中文

LOCK

Lock front panel and make all buttons invalid. After panel is locked, MENU button flashes. The LCD shows info as follow:

FRONT PANEL LOCKED
PRESS MENU 3S UNLOCK

After front panel is unlocked, MENU button light goes out.

WORK TIME

Show the total boot times and working time up to now.

BOOT TIMES: 15
TOTAL TIME:650MIN

Button Operation

Power Up

After the device is connect to power, it will automatically boot up. After the device is powered up LCD shows the following:



Select output



Press any button among 1-8 in OUT area, the corresponding output can be selected and the button light illuminates.

Select input

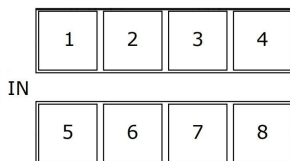

After the output is selected, press the button among 1-8 in IN area and the button flashes. The corresponding input is taken to the output immediately.

Select ALL output



Press button ALL and all buttons in OUT area light up, then press any button in IN area, all outputs display the one selected input. For example, after pressing button ALL and press button 6 in IN area, all the displays shows the image of input 6. The LCD on device shows the info below:

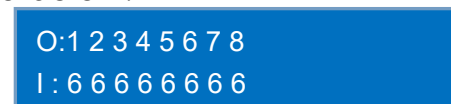

Press button ALL again, all lights go out except button 1 in OUT.

SAVE

If the IN→OUT (matrix) setting need to be saved, press button SAVE , LCD will show instruction as below

SAVE TO: _

At this time, press any button among 1-8 in IN area, it means save to the corresponding position of 1-8, i.e., press button 2 means save to SAVE 2. Press any button among 1-8 in OUT area, it means save to corresponding position of 9-16, i.e., press button 1 means save to SAVE9, button 7 means SAVE15.

LOAD

If the saved setting need to be recalled,press button LOAD , LCD will show as below

LOAD FROM: _

The button indicating saved position illuminates and the latest saved position flashes. For example, in previous operation, there are 3 saved position, SAVE2, SAVE9, SAVE15, SAVE15 is the latest one, button 2 in IN area, button 1 in OUT area illuminate and button 7 in OUT area flashes.

Press the above illuminating or flashing button to Load the corresponding SAVE.

POWER-STAND BY MODE

Press button POWER  LCD shows the indication as follow:

ENTER STANDBY MODE
YES<ENTER>,NO<MENU>

In stand by mode, press POWER for 3S, all buttons flashes one by one immediately and LCD shows

RGBLINK
FLEX 8

5S later, the device goes back to work and in the status before stand by.

Software Operation

Install Software

Minimum Requirements

Windows

Operation System	Windows 7/8/10
Processor	1GHz/32 bit or 64 bit processor
Memory	2Gb
Hard Disk	16Gb
Graphics	128Mb/DirectX9
Display	1280X720

Mac

Operation System	Mac OS
Processor	1.0GHz+
Memory	512M+
Hard Disk	512M+
Graphics	512M+
Display	1366x768

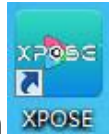

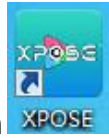
1. Double click icon  , it will pop-up the Installer Language box, select the language, for example, select “English”, and click “OK” to confirm.



It will pop-up the installer box, and click “Next” to install, as follows:



2. Select “Browse...” to select the XPOSE software install location and click install:

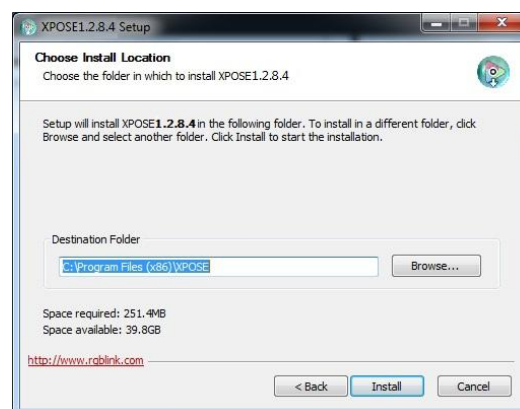

3. User should get the rights in “Roles Management” when install the software to disk C if the system is Windows 7 or above.

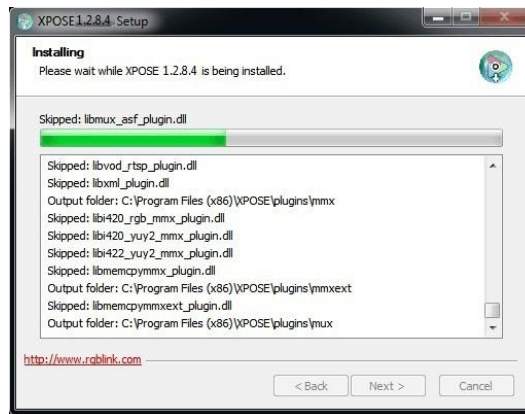

4. Click “Finish” and is ready to run the XPOSE management software:



Login to the Software



1. Double click the icon XPOSE on the desktop, then login into the interface. The user name is Admin, and defaultly there is no password. Select "FLEX 8", select language "English" and enter the software by clicking "Login".

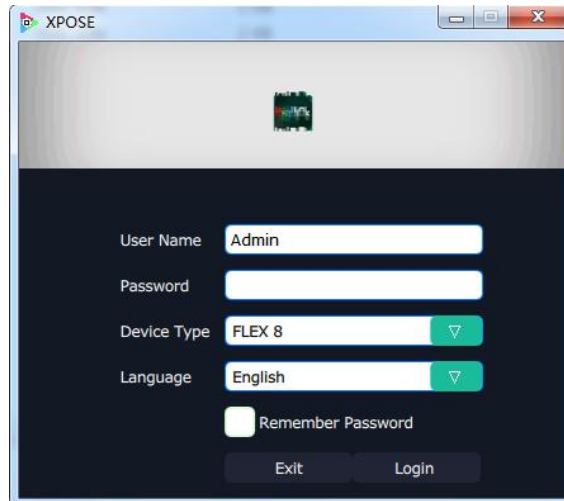

2. If user wants to change the language to Chinese, click the drop down arrow after "Language" and select "中文", then click "Login" to enter the software.



3. After entering the software, the main interface shows as follows:

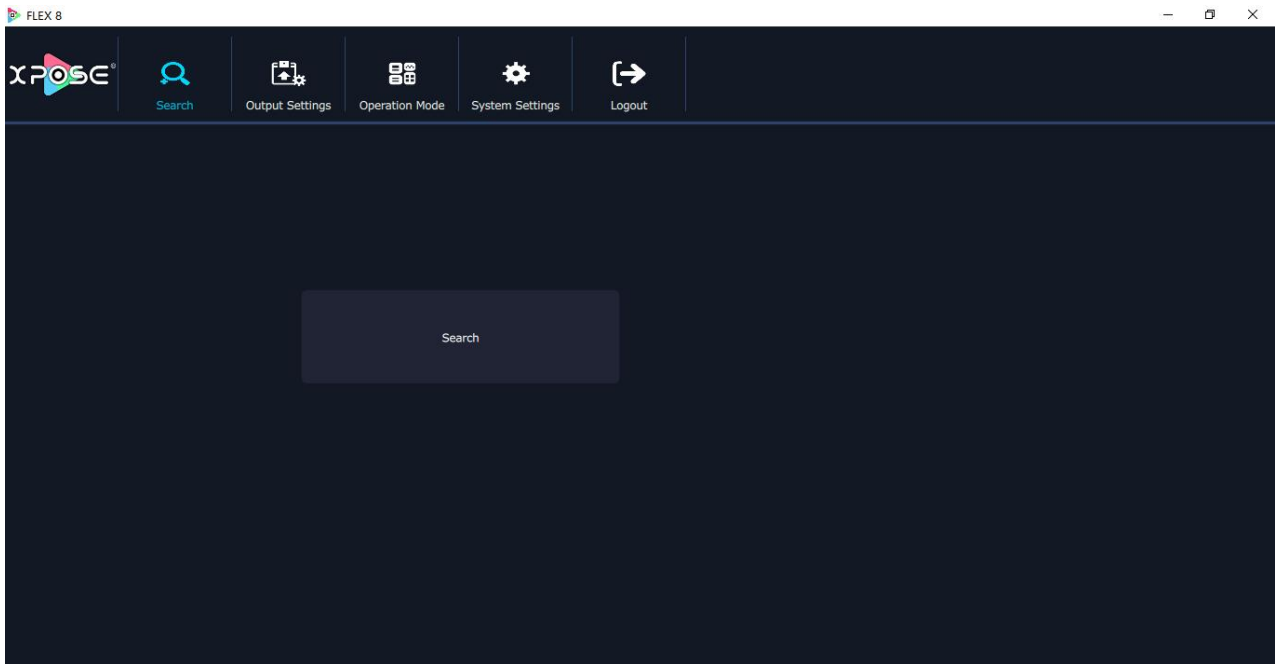

XPOSE management software consists of Output Setting, Operation Mode, System Settings and Log out. In the following parts come with the detail.

Connect to Software

Connect the remote controller PC which runs XPOSE to Flex 8 by the network cable In The Box.

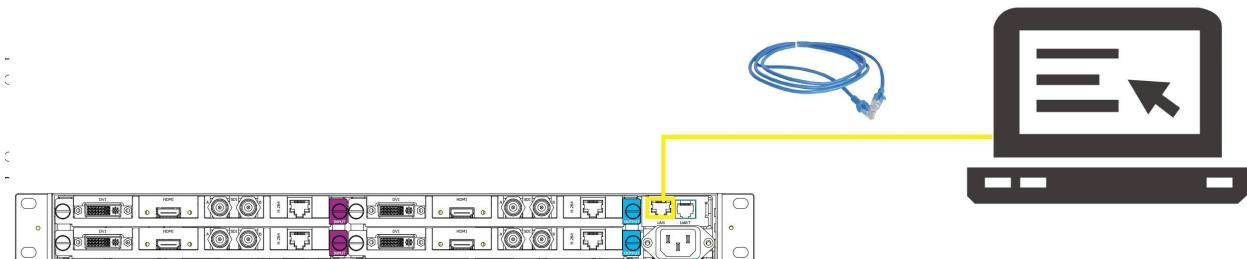

Click search  to find the device as follows:



and get the device to XPOSE

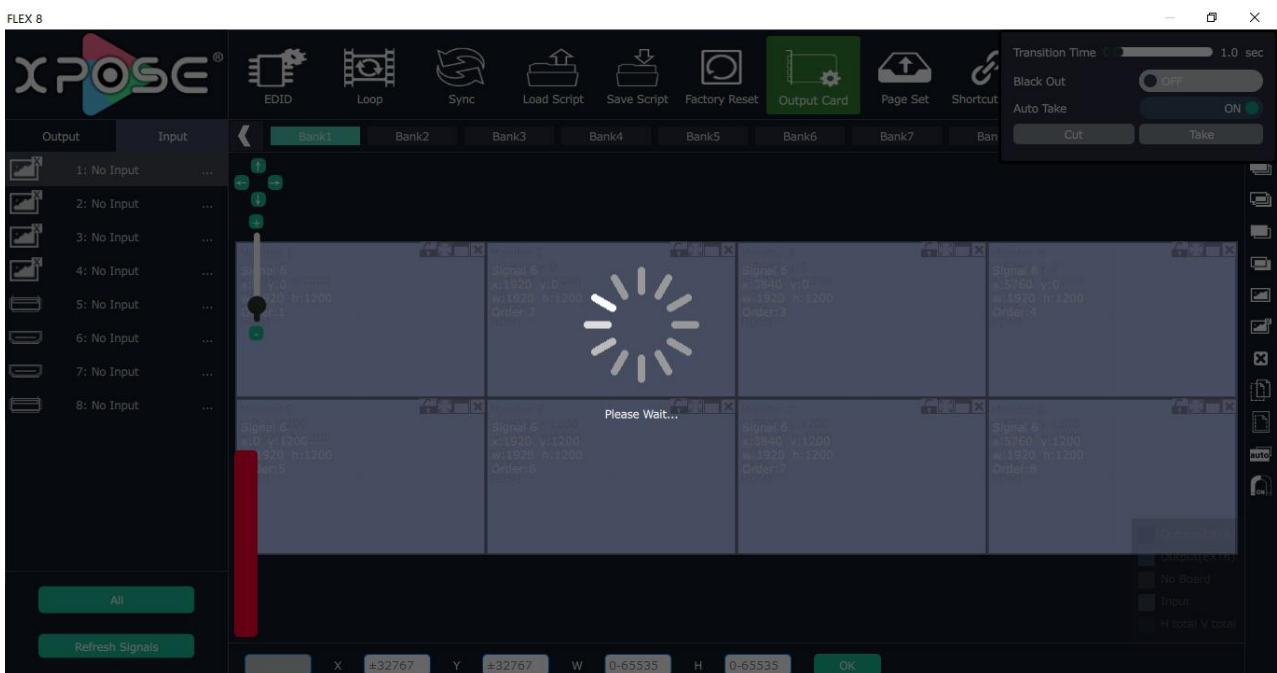

After Sync, enter the following interface.

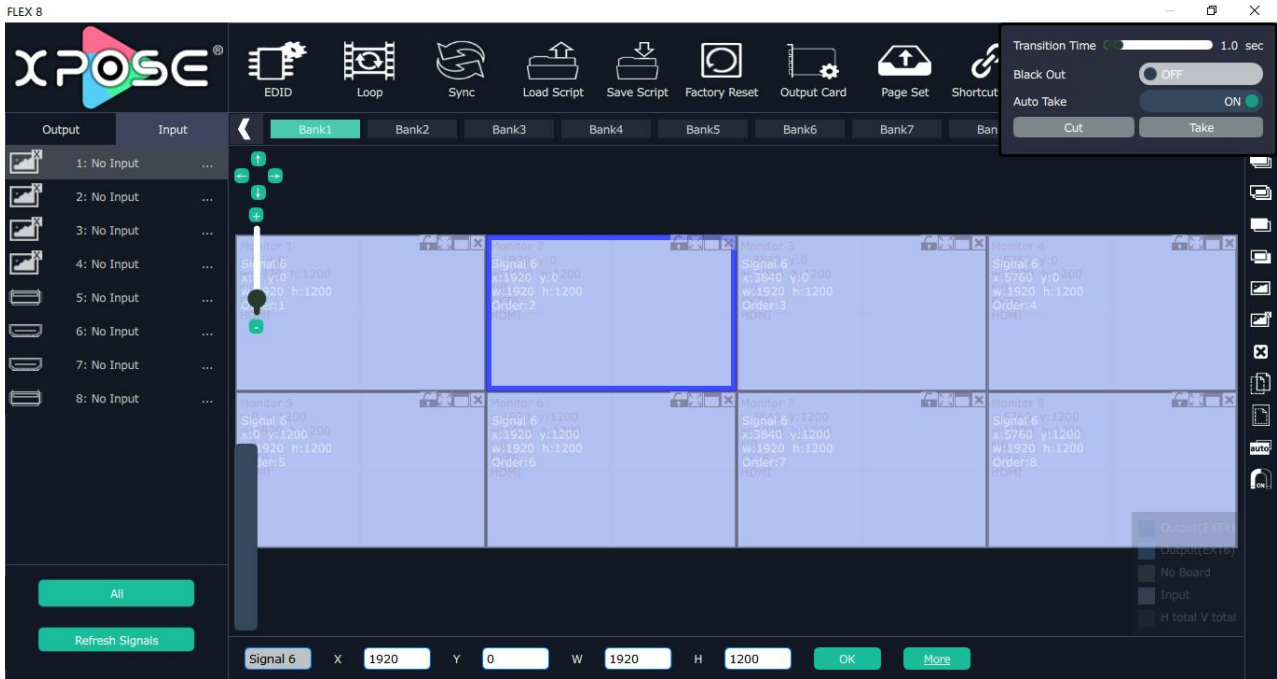

Close the current interface, just click the X    on the right top corner and enter the main menu interface.

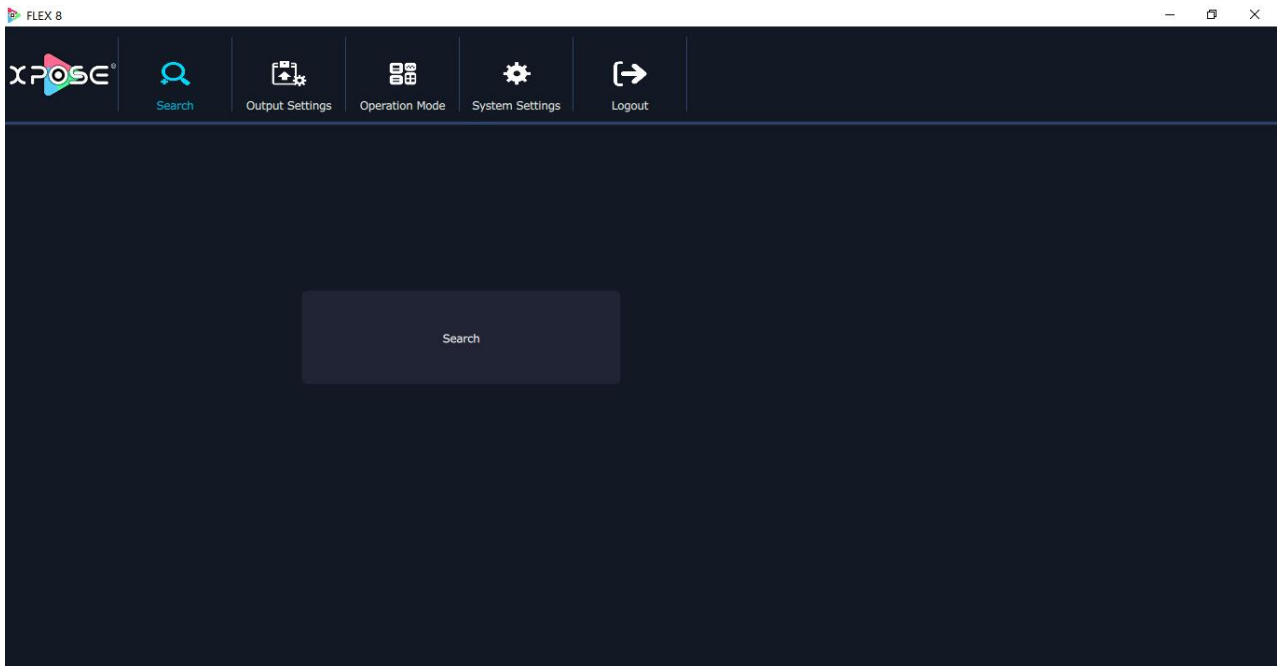

Output Setting



Click Output setting  and enter the interface as below:

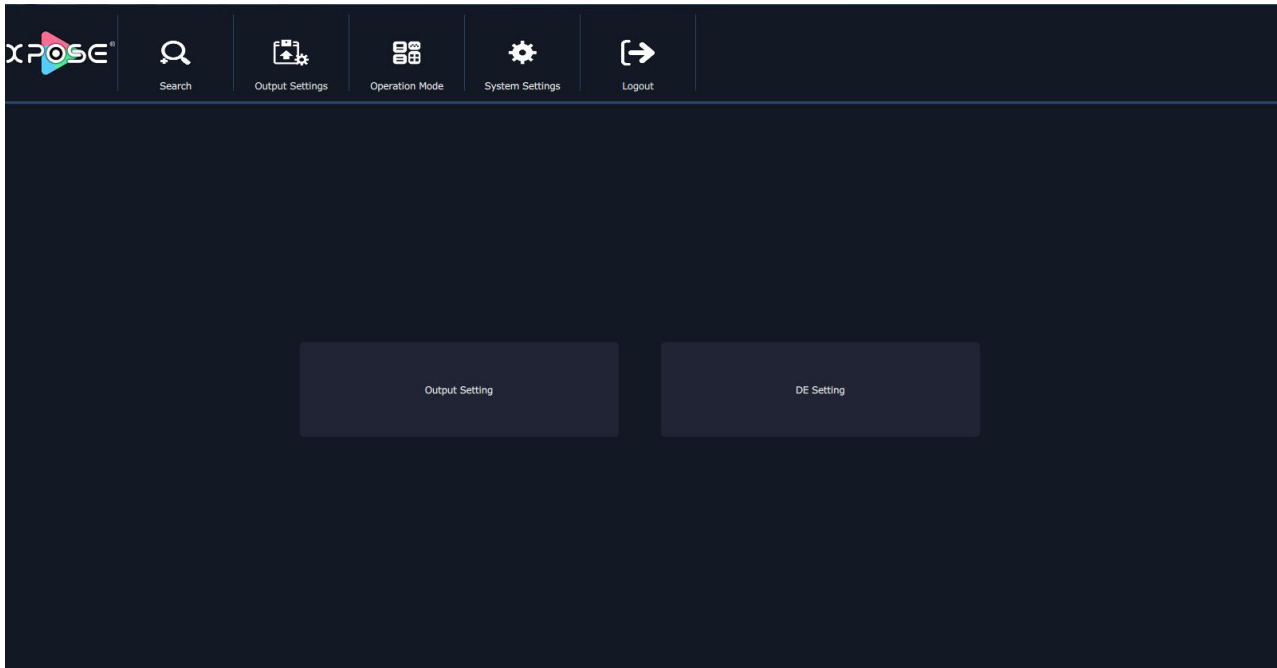

Output setting

choose output resolution here

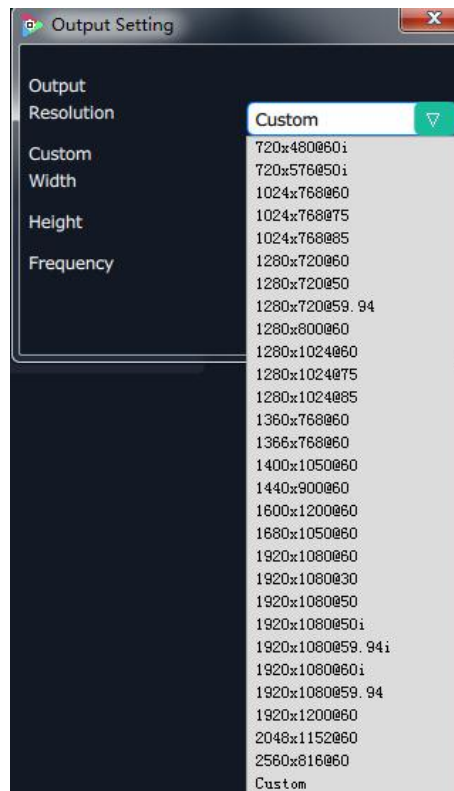

There are 28 standard resolution format available and users can choose custom the output resolution by choose "Custom " and type in the Custom Width. Height and Frequency.

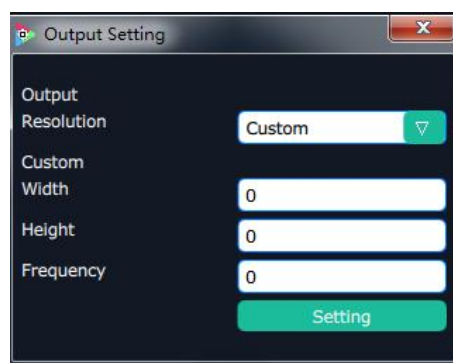

User can custom the resolution if no proper resolution in the list,

Note: avoid using following resolution

720×480i@60Hz and 720×576i@50Hz (not supported on all output modules, except via adapter through DVI module connected to EXT 4F-OM matrix output ext interface),

2560×816@60Hz and 2048×1152@60Hz (not supported on DVI and HDMI output) .

Then click Setting  to confirm.

DE Setting

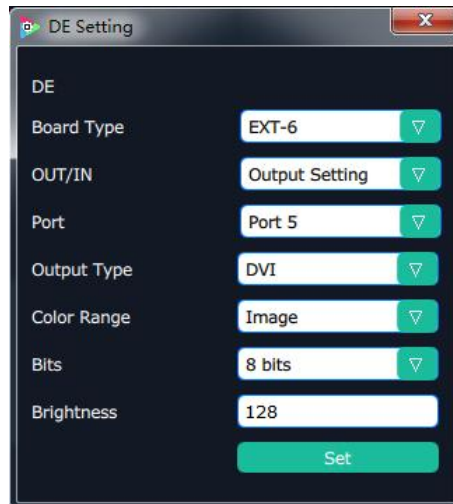

Board Type: select EXT-6 (EXT4F-OS) or EXT-4 (EXT4F-OM) based on the real installation of the device.

Out/In: Output setting or Input setting

Port:Port1-Port 8 to choose

Output Type:DVI or HDMI

Color Range:Image or Video

Bits:8bit

Brightness:0-128

Operation Mode

There are 2 working modes, including the Matrix mode and Splitting Mode. Click the “Operation Mode”, and enter the interface as follows:

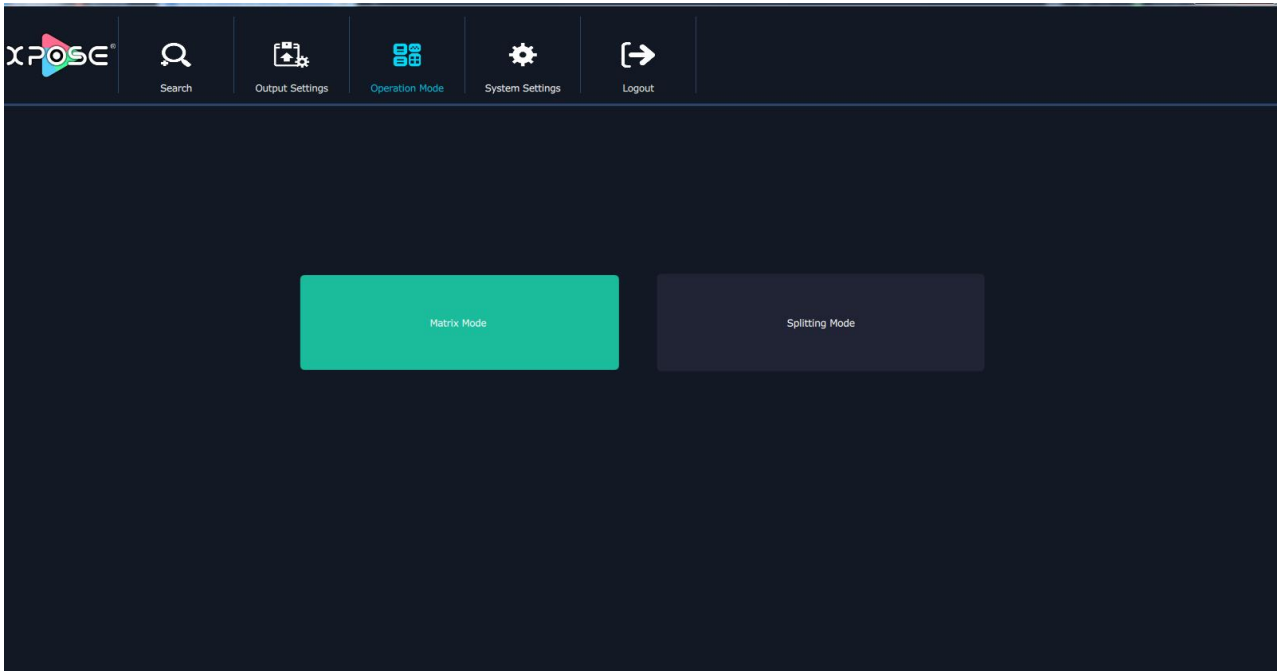

Matrix Mode and Splitting Mode are included in operation mode, specific as follows:

Matrix Mode

Click the “Matrix Mode”, and enter to the interface as follows:

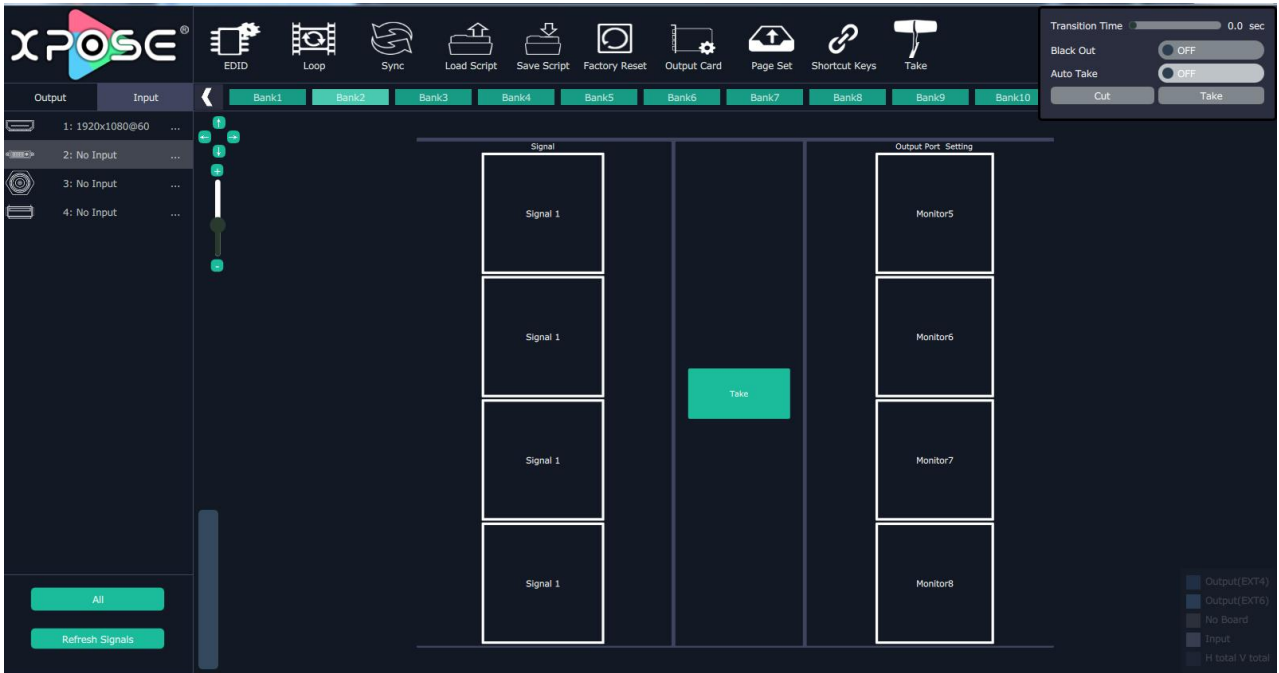

In→Out

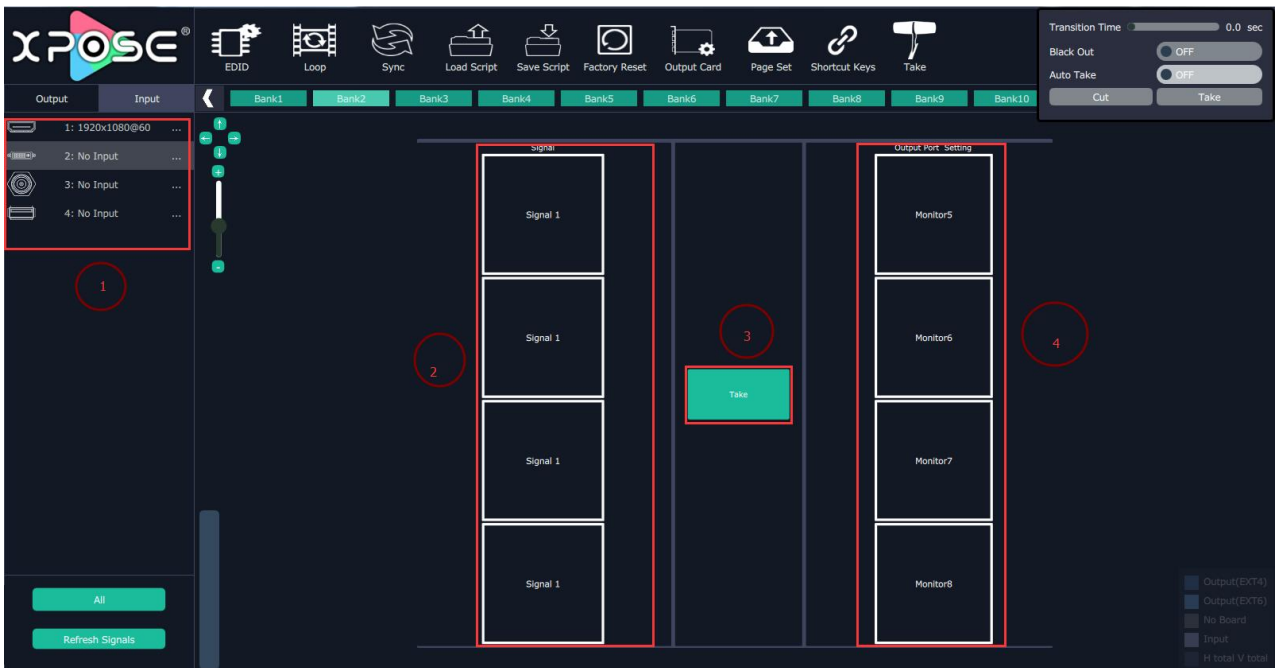

1. Choose input source from the signal source list
2. Drag the signal source to Signal
3. Click Take
4. The display will show the input source correspondingly as the following show:

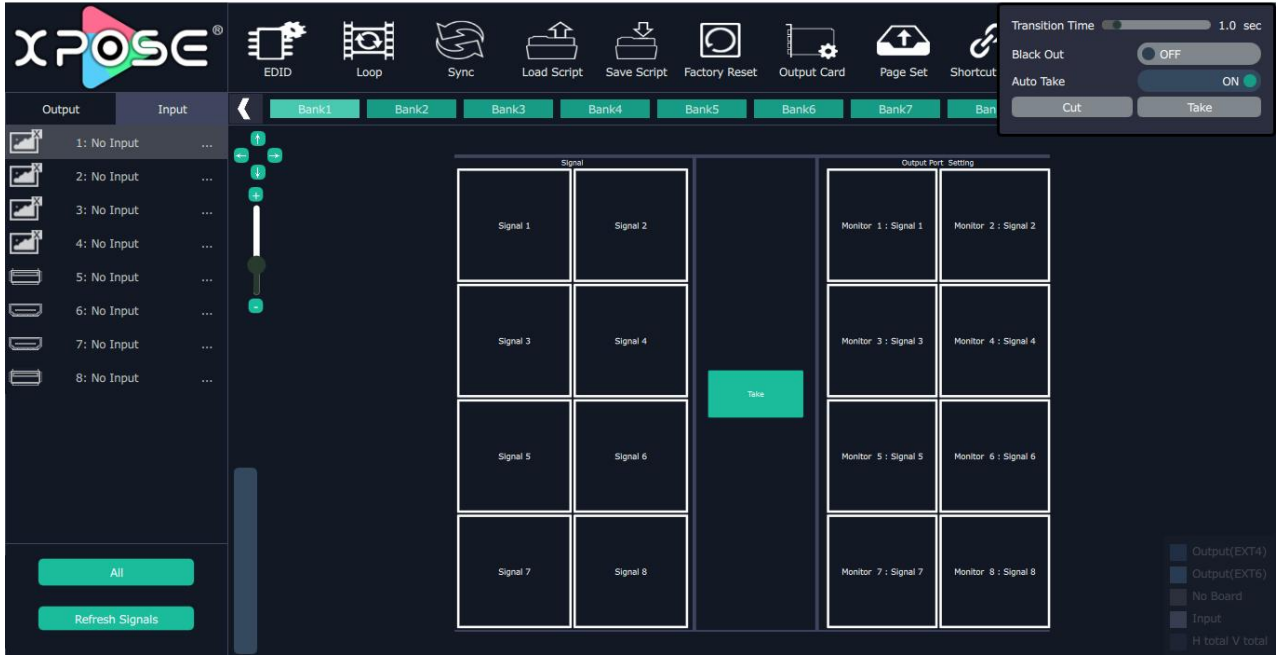

For FLEX 8 with matrix front panel, users can use XPOSE or front panel panel to control the device.

For FLEX 8 with basic front panel, users can only use XPOSE to control.

1 IN-All Out

Choose one input source from the signal source list

Click All 

Click Take 

All display will show the one chosen input source as the following show:

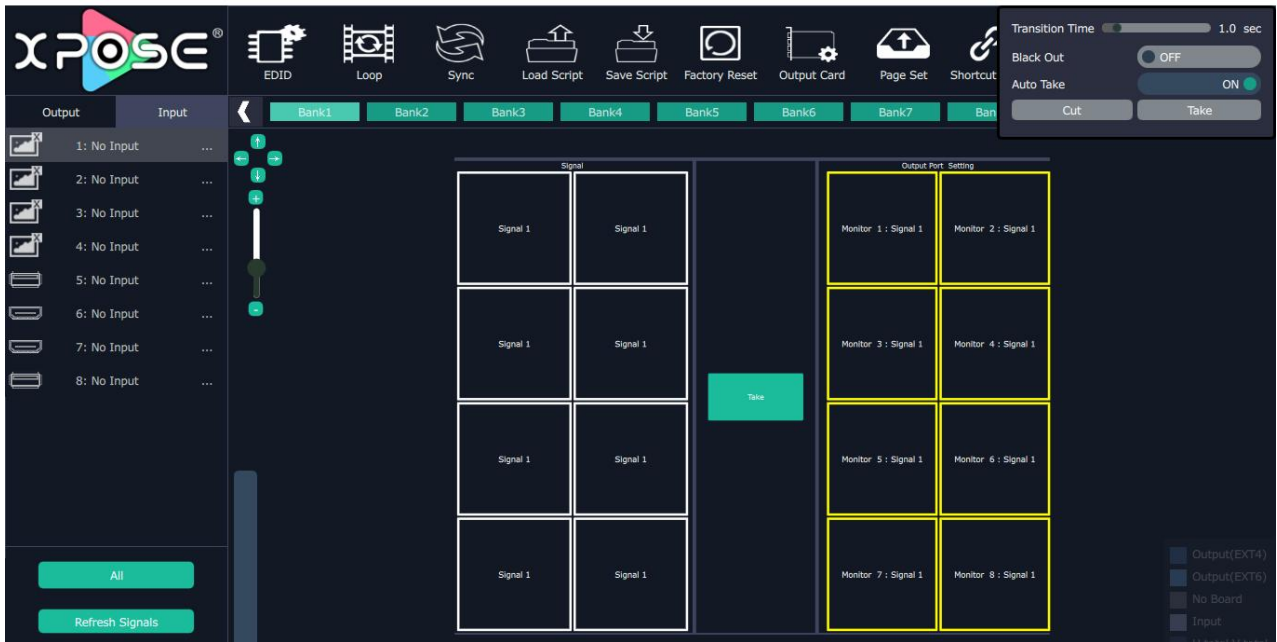

Output Card

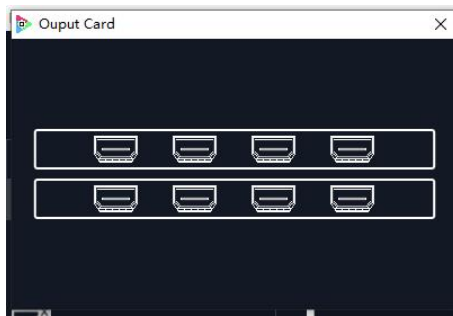

Click each output port, users can set output resolution of each port

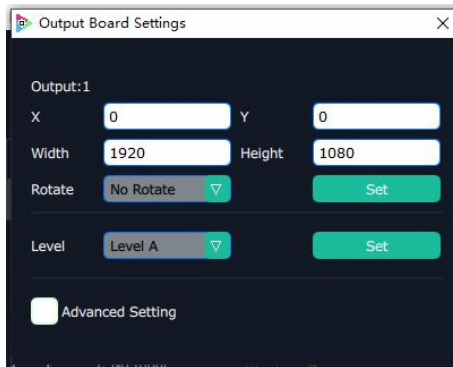

Choose Advance, scale and crop setting can be done.

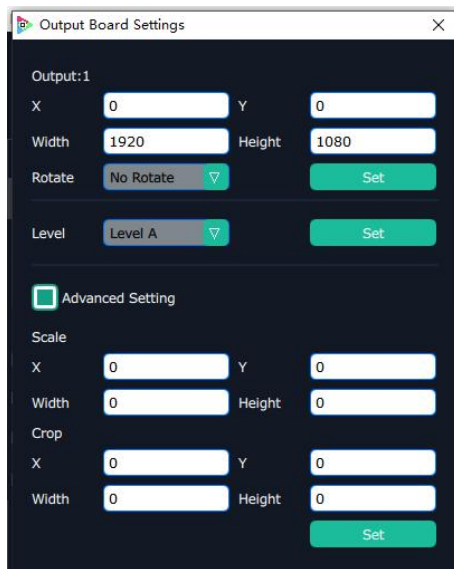

Splitting Mode

Click the “Splitting Mode”, and pop-up window as follow:

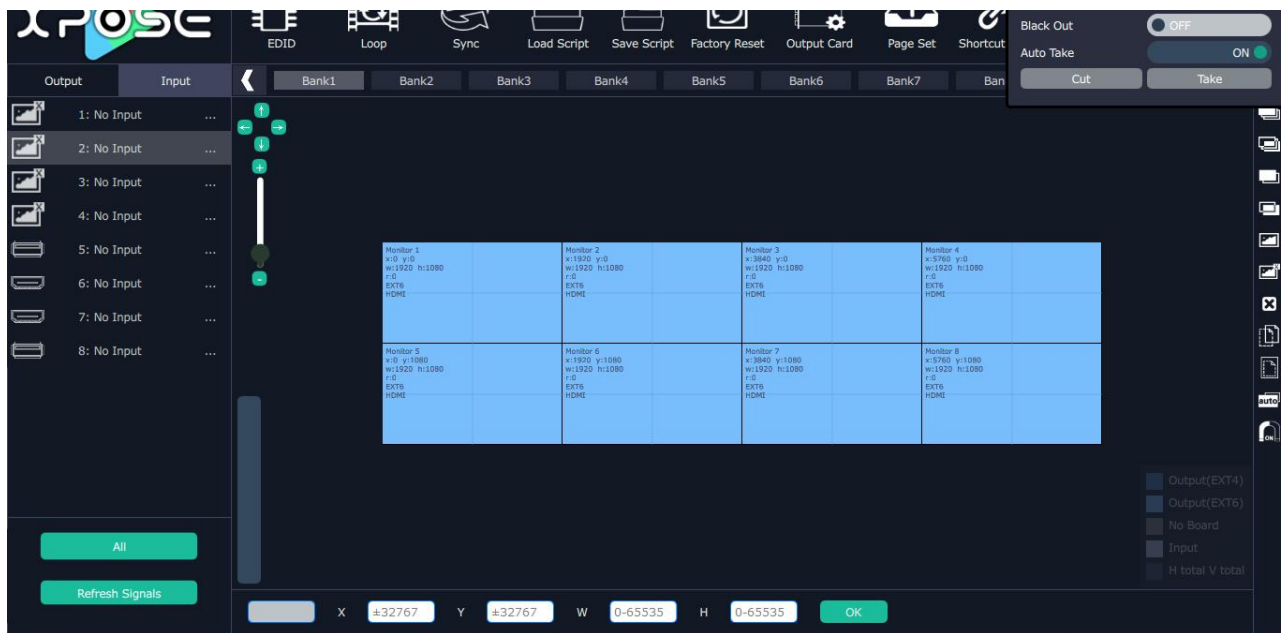

To do quick splitting, users can choose signal from signal list and drag it to the window. Drag the border of the layer to cover all the monitors.

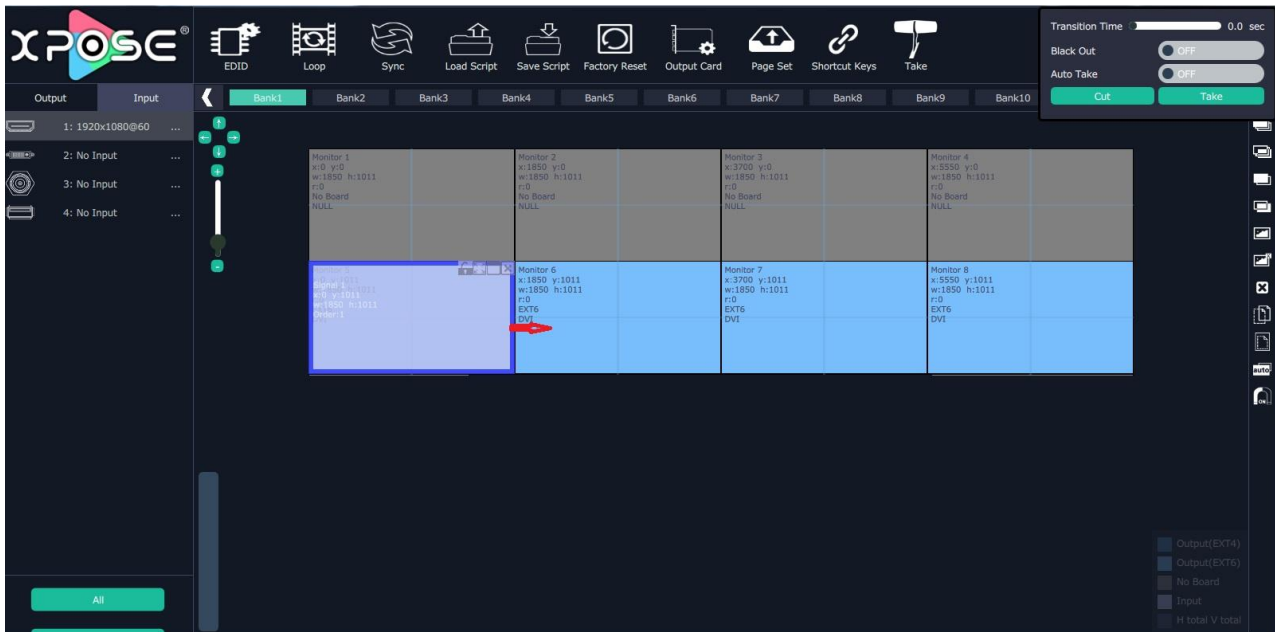

For example, do splitting on 4 monitors, after setting the resolution of each output, drag the input source to the output window and cover up all outputs. To make sure the signal cover up all outputs more exactly, users can type in the total width and height of the desired video wall size.

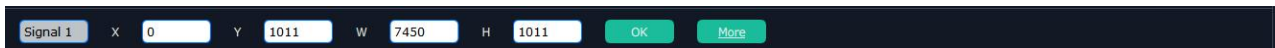

Input Setting

The signal list is shown as follows:

Output	Input
 1: 64x64@0	...
 2: No Input	...
 3: No Input	...
 4: No Input	...
 5: No Input	...
 6: No Input	...
 7: No Input	...
 8: No Input	...

It displays the input module type, the quantity of inputs and input format. Click"... "after the format of input for the following settings:

For HDMI and SDI input there are settings as below:



Change Name: Select “New Name”, and input the new name, click “OK” after setting.

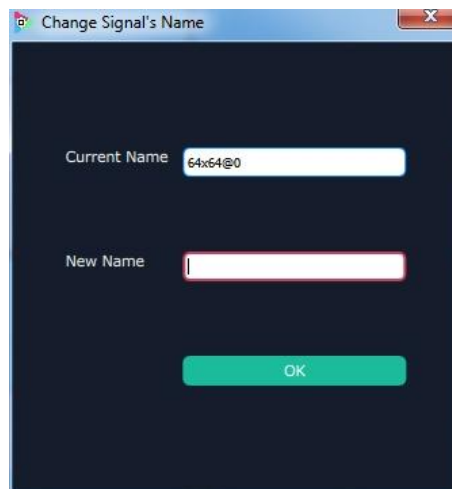

Set Input Property: Right click the input and select “Input Property”, it will enter to the interface as follows:



Scale: Set the X, Y, width and height.

Crop: Crop the left, top, width and height.

Display Mode: Select “Live” or “Freeze”.

Mirror: Enable or disable the mirror function, default "OFF".

Bypass Mode: Enable or disable the bypass mode. When select "ON", the output **format** will be the same with the input format.

Alpha: Set the alpha, the adjustment range is 0~128.

Sharpness: Set the sharpness, the adjustment range is 0~100.

Brightness: Set the brightness, the adjustment range is 0~100.

Contrast: Set the contrast, the adjustment range is 0~100.

Saturation: Set the saturation, the adjustment range is 0~100.

Color Term: Set the color temp (red, green and blue), the adjustment range is 0~100.

Reset: Select "Reset", the input property will be recover to factory setting.

Test Pattern: Slide the Test Pattern switch to enable or disable the function.

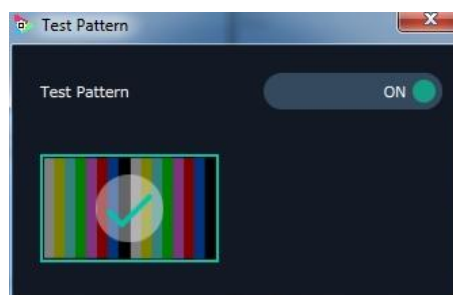

For USB input setting there is USB player setting



select "USB Player", it will enter to the USB Player interface, including movie and picture, default play the USB picture.

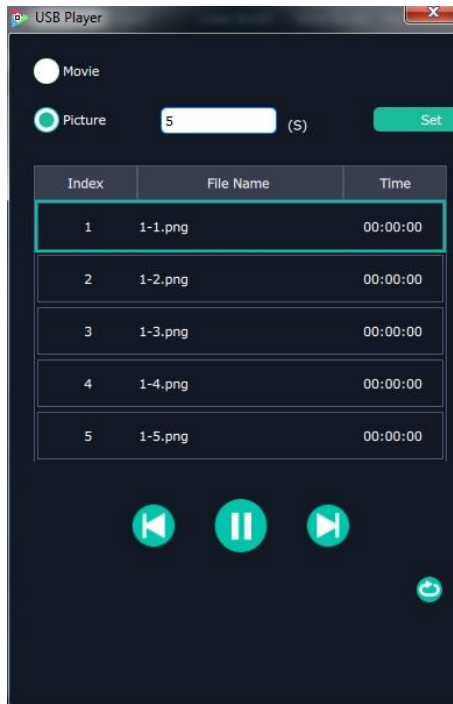

USB movie player setting: Can select play in order, random, single cycle and all cycle, switch to pre or next, pause or play, and read the movie name, progress bar and time.

USB picture play time: Click the picture, it will display the setting interface, default the time is 0s. Set the switch time, and click "Set".

USB picture player setting: Can select play in order, random, single cycle and all cycle, and switch to pre or next, pause or play.

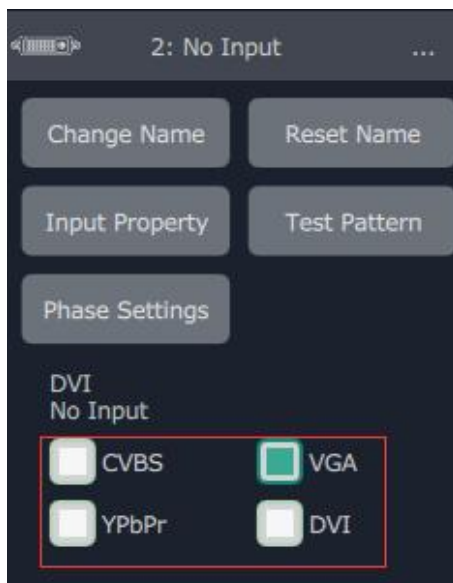

DVI module of FLEX 8 is compatible with VGA, CVBS, YPbPr signals via adapter , therefore for other signal such as VGA input, users need to choose VGA in DVI input setting as below:

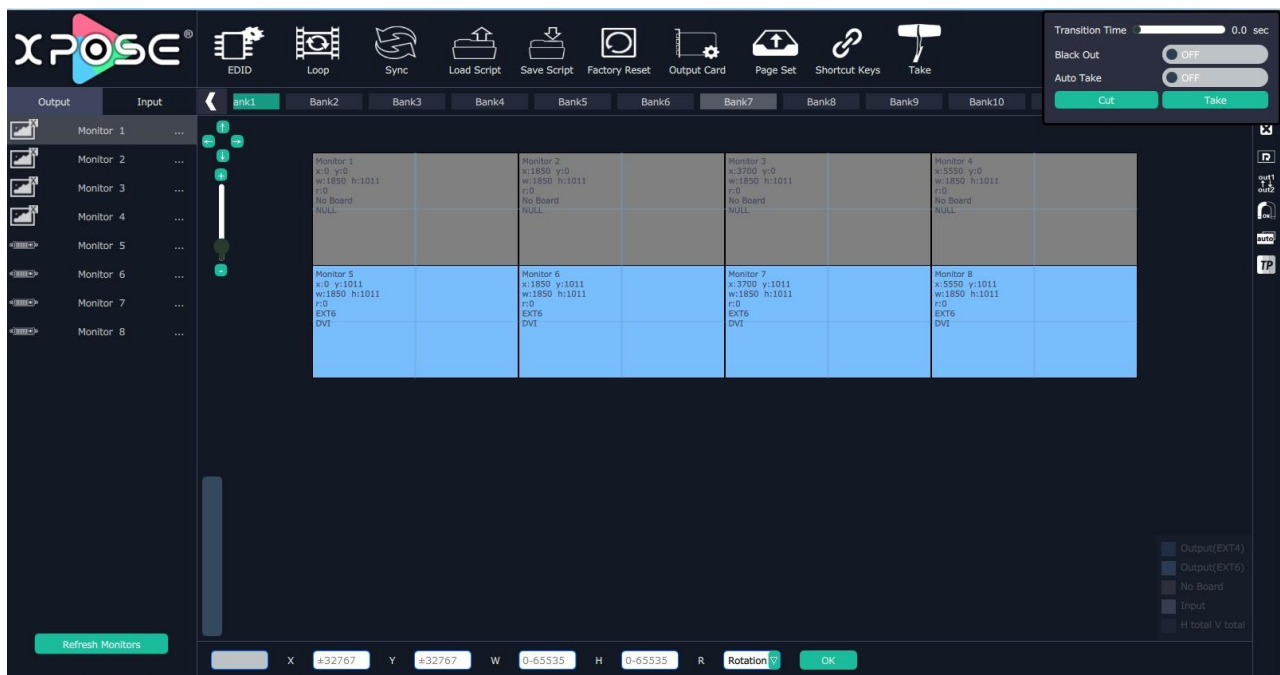

Output Setting

Click on shortcut , it will enter the interface as follows:



Close monitor: Click the icon  on the top right corner of the monitor to close one monitor, or click the shortcut  on the right side of the interface to close all monitors.

Reset outputs: User can reset outputs by clicking the shortcut  on the right side of the interface.

Swap outputs: User can swap outputs by clicking the shortcut  on the right side of the interface, as shown in the figure below.

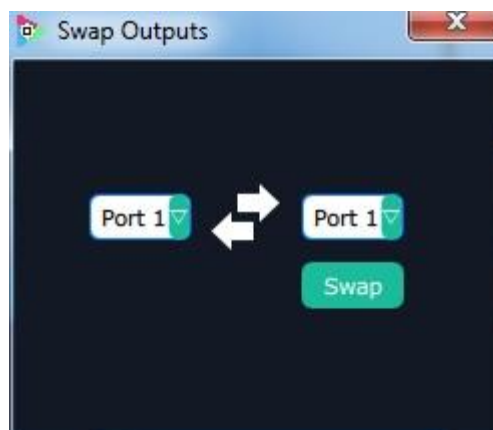

Swap port1 and port4

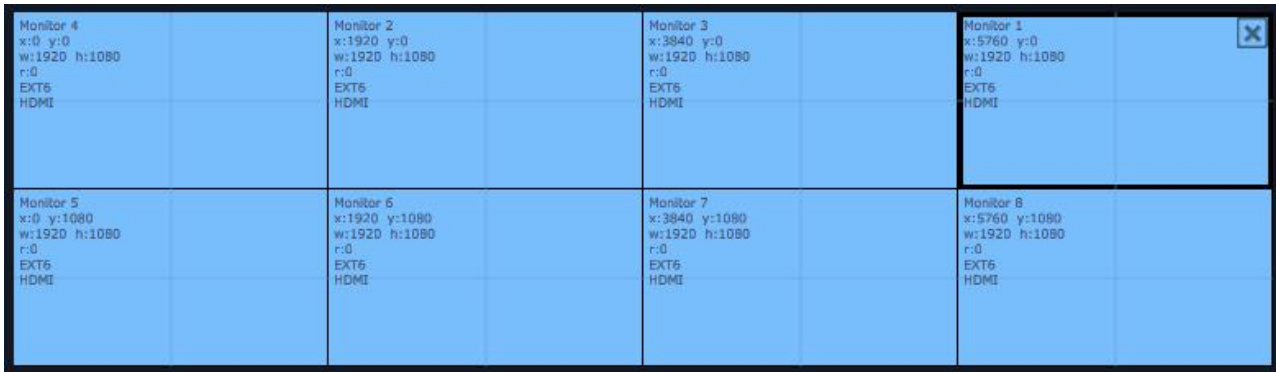

Auto file: User can enable or disable the auto tile function by clicking the auto file



shortcut on the right side of the interface. If select auto tile "ON", the layer will automatically snap to the output grid when move the layer to the position within the threshold value.

Monitor Size and Position Setting: Move the mouse to the lower right brink of the monitor, and press the left key of the mouse. Move the mouse to the suitable position and release the mouse. But this method can only adjust the size and location roughly, if an accurate adjustment is needed, select the monitor, and set the X, Y, width and height in the bottom of the interface.



Monitor Size changed equivalently: Select any monitor, for example, select monitor 1, and adjust the size. Click this monitor, then press button C and don't let go, select the monitor that will set, the size of the selected monitor will be changed to the same size of monitor 1, as shown in the figure below:

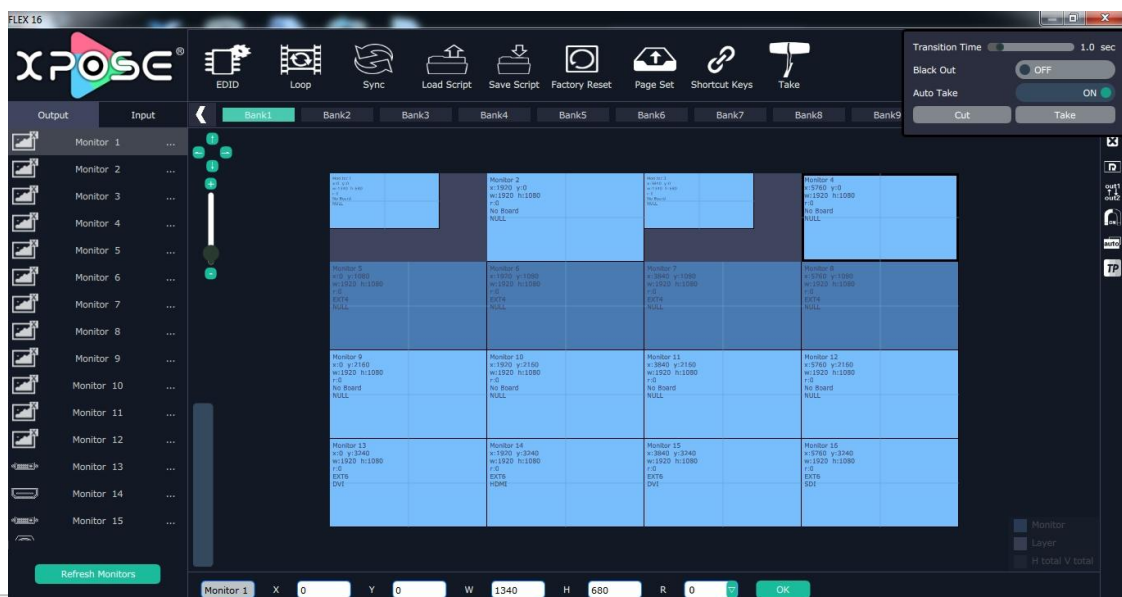

Rotation: Select the monitor, and set the rotation as 0°, 90°, 180° and 270° in the bottom of the interface. Click “OK” to confirm. As shown in the figure below:



Note: select any 1 out of the 4 outputs which are connected to the same EXT extension interface.

Right click the monitor can also rotate the monitor.

Adjust Output Area : Move the mouse to the output area and slide the mouse wheel, the output area size can be zoom in and out. There are three other ways to adjust the position and size of the output area.

1. Auto Adaptive
2. Adjust the proportion of output area on the interface window automatically.
3. Up Down Left Right Arrow to move the position
4. + - to adjust the size

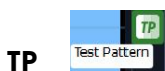
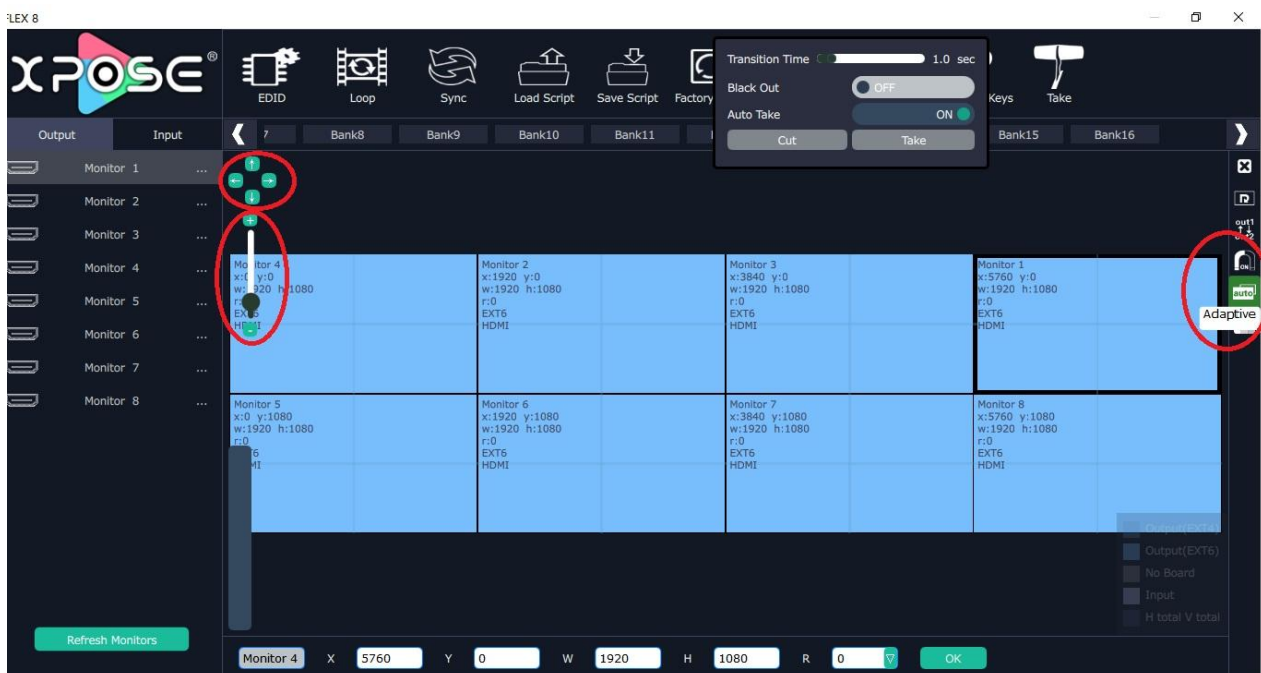

TP

Choose
Board 1-4
Color Choose: Signal Souce, Color Bar, Pure Color

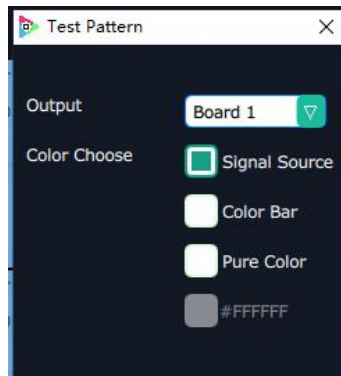

Set TP OK

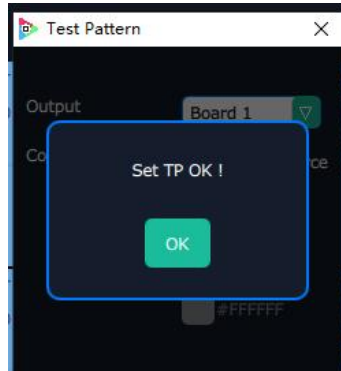

Adjust Layer: Two ways can change the size and location of the opened layer:



a. Drag the opened layer by mouse. The details are: move the mouse to the brink of the opened layer, when the mouse shows " $\leftarrow\rightarrow$ ", press the left key of the mouse and drag the window to a suitable size and then release the mouse. Or move the mouse to the lower right of the opened layer, press the left key of the mouse and drag the window to a suitable size and then release the mouse. Move the mouse to the opened layer and press the left key of the mouse and move the mouse, then the layer will be moved, release the mouse when moved to the suitable location. But this method can only adjust the size and location roughly, if an accurate adjustment is needed, the second method can be used.

b. Select the layer to be adjusted, and set the X, Y, width and height in the bottom of the interface.



Hierarchical relations between layers: After creating the layers, the hierarchical relations can be changed by the following: click the shortcut key bring layer to front



"", send layer to bottom "", layer forward " " or layer

backward “”. The layer can be set as background by click “” and click “” to close layer background.

Close one layer or all layers: Click the icon  on the top right corner of the layer to close one layer, or click the shortcut key “” to close all layers.

Lock the layer: Click the icon  on the top right corner of the layer to lock the layer, the layer can't be moved or adjusted if be locked.

Full the layer: Click the icon  on the top right corner of the layer to full cell, and click the icon  to full screen.

Copy and paste bank: Select the bank that to copy, and click the copy bank shortcut “” on the right side of the interface, then select the bank that to paste, and click the paste bank shortcut “”. The selected layer will pasted to the bank.

Adaptive: If scale the output area to a large area, click the adaptive shortcut “” on the right side of the interface, the output area will be return to the best position.

Layer Property Setting

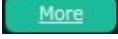
Select the layer to be adjusted, click the More shortcut “” in the bottom of the interface, and enter the interface as follows:



Scale: Set the X, Y, width and height.

Crop: Crop the left, top, width and height.

Display Mode: Select "Live" or "Freeze".

Mirror: Enable or disable the mirror function, default "OFF".

Bypass Mode: Enable or disable the bypass mode. When select "ON", the output format will be the same with the input format.

Alpha: Set the alpha, the adjustment range is 0~128.

Sharpness: Set the sharpness, the adjustment range is 0~100.

Brightness: Set the brightness, the adjustment range is 0~100.

Contrast: Set the contrast, the adjustment range is 0~100.

Saturation: Set the saturation, the adjustment range is 0~100.

Color Term: Set the color temp (red, green and blue), the adjustment range is 0~100.

Reset: Select "Reset", the input property will be recover to factory setting.

Take

The take interface is shown as the figure below:

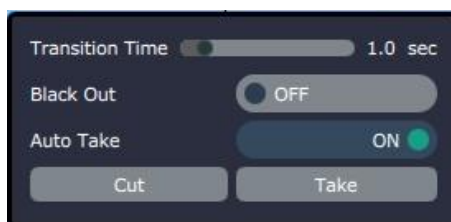

Set the transition time, and the adjustment range is 0~10S.

Slide the black out switch to enable or disable the black function. Auto take on is the default state. If select black out and auto take on, the preview image will black or seamless switch to LED display instantaneously.

Click "Cut" or "Take", the preview will be cut or seamless switch to LED display.

EDID



Click the EDID shortcut “**EDID**”, and pop-up window with input ports that support EDID as follows:

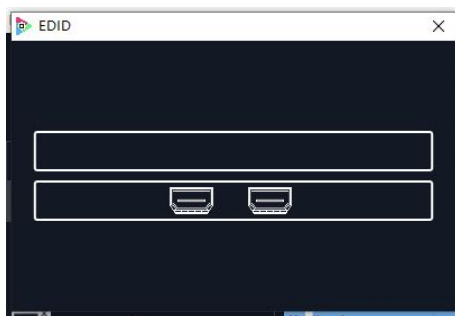

The special display project or LED display application would like to require special resolution settings to meet the requirement. Select the suitable input port to customize the EDID. As shown in the figure below:

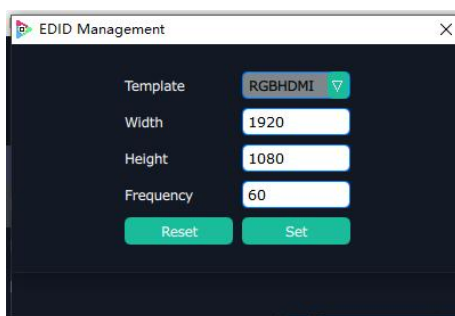

Loop



Click the loop shortcut “**Loop**”, and pop-up window as follows:

Timing Loop

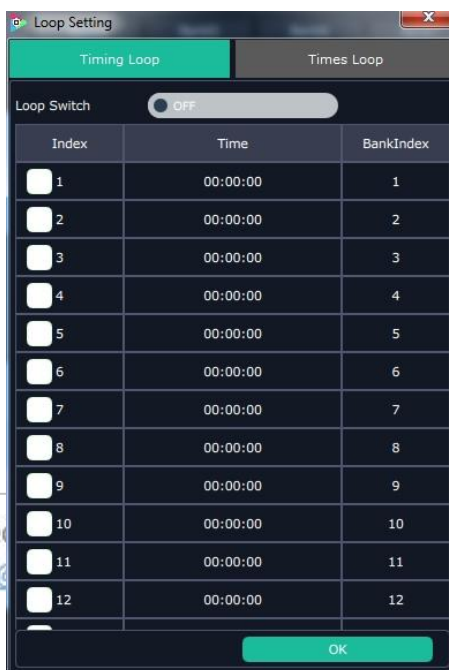

Slide the loop switch to enable or disable the timing loop function for the bank. If select "ON", the exact time to play the bank can be set.

Times Loop

Slide the loop switch to enable or disable the times loop function for the bank. If select "ON", the exact length of time to play the bank can be set.

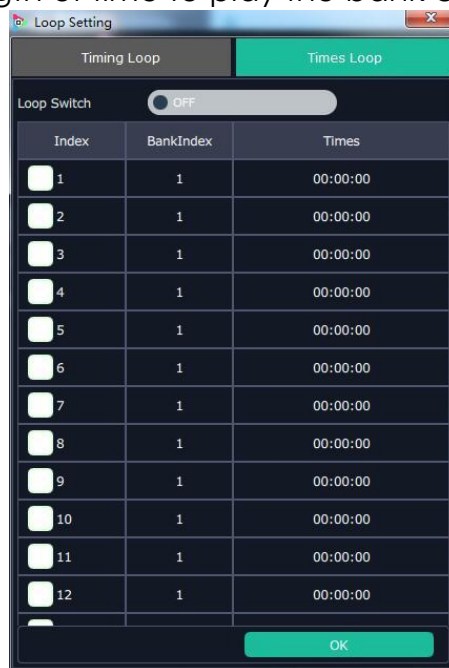

Sync



Click the sync shortcut "Sync" to synchronize the current data.

Load Script



Click the load script shortcut "Load Script", user can load the data from the computer.

Save Script



Click the save script shortcut “Save Script”, user can save the current data to local computer (Save Script) or chose Offline Saved to save saved bank to local computer

Offline Saved as follows:

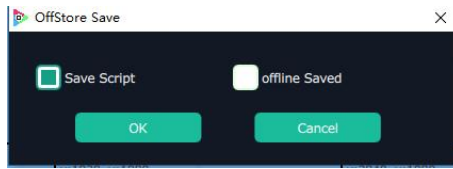

Offline Saved

Choose offline saved, it will pop window with saved banks.



Choose the bank to be save and click OK, bank will be saved to local computer.

Factory Reset



Click the factory reset shortcut “Factory Reset” to reset to factory settings.



Factory reset is to go back to the factory initial setting of each IN-OUT.

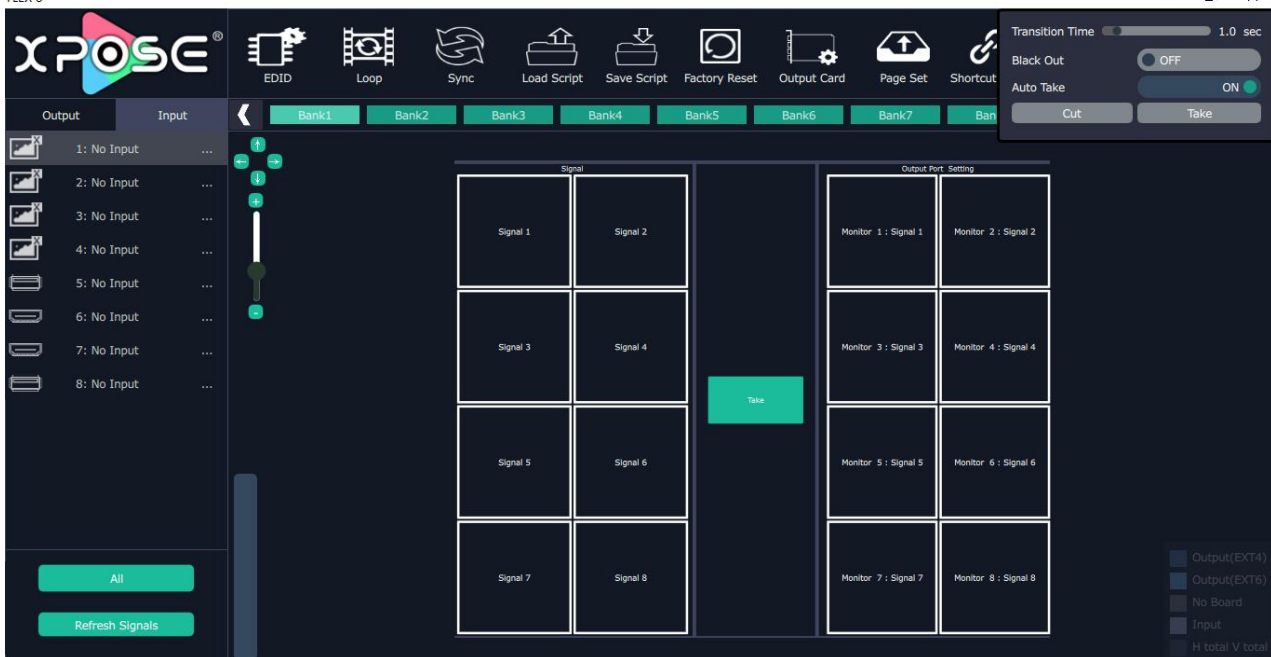

Page Set



Click the page set shortcut “Page Set” to load and save pages.

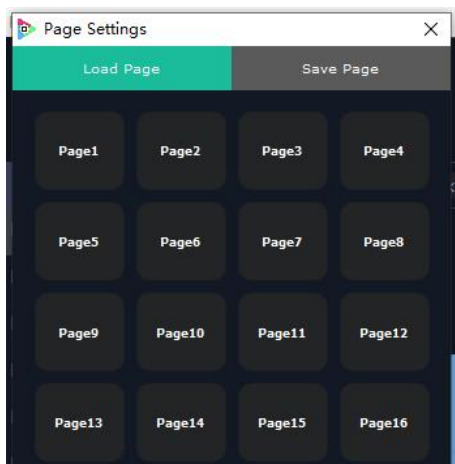

Save Page

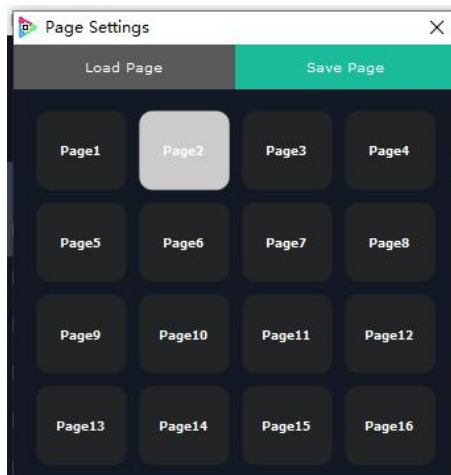

Grey page indicate this page has been used, a setting has been saved in this page.

Load Page

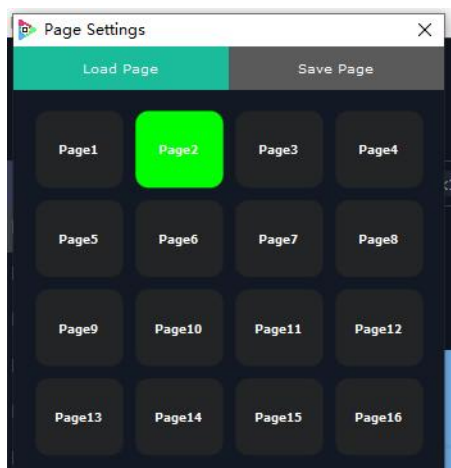

Green page indicated that there is a saved available to load.

Shortcut Keys



Click the shortcut “”, and pop-up window as follows:

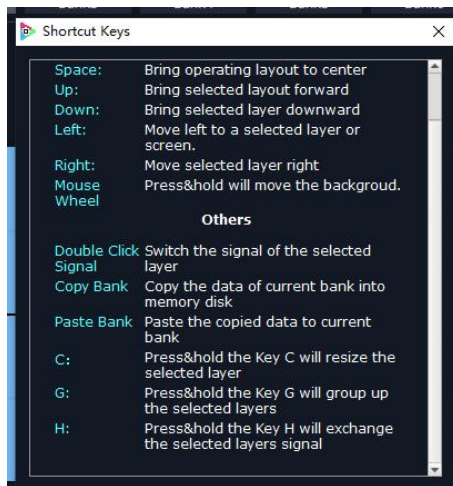

Use shortcut key to operate fast and easily.

System Settings

Click "System Settings" in the main interface:

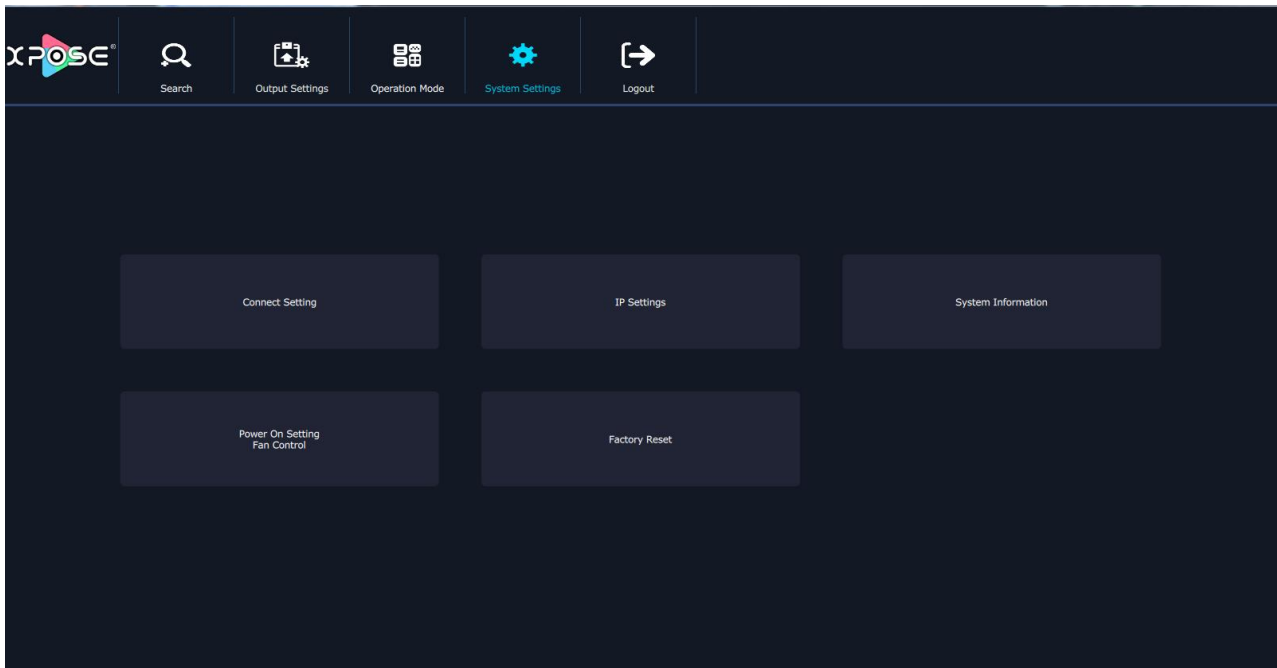

Connect Setting

Click "Connect Setting": Select "COM Port" and "Baud Rate", click the drop down arrow after them, and click "OK".

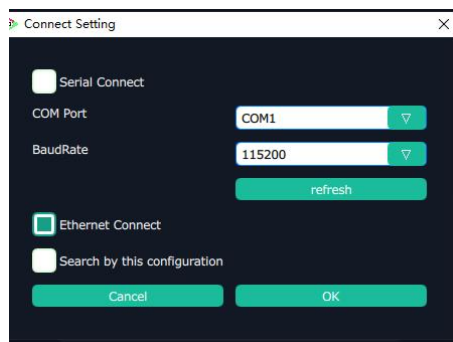

Setting the device connecting ways: Serial Connect, Ethernet Connect and Search by this configuration.

After setting "COM Port" and "Baud Rate", pop-up window as follows:

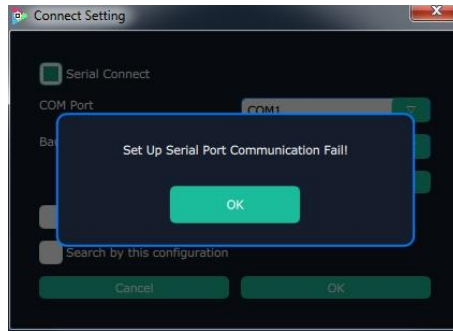

IP Settings

Click the "IP Settings", and pop-up window as follows:

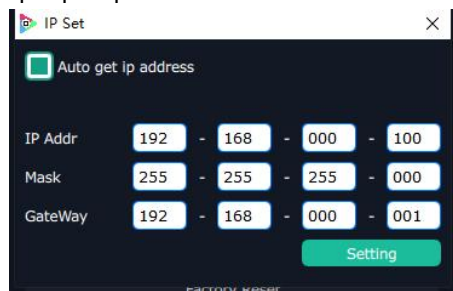

Default "Auto get IP address". Users can also set IP address, Mask and GateWay manually. This is usually used if one computer control some devices or remote control. It takes effect after reboot the software if change IP through network.

System Information

Click "System Information", and pop-up window as follows:



Display the device version information. Including Model Number, Serial Number, IP Address, firmware version, etc.

Factory Reset

Click "Factory Reset", and pop-up window as follows:

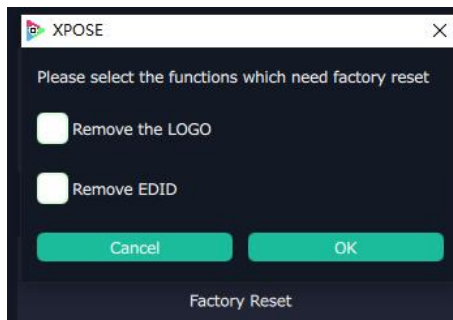

Click "OK" or "Cancel" to confirm the reset.

Power On Setting Fan Control

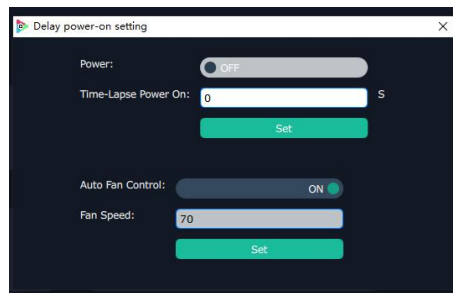

To enable Delay Power On Setting, slide OFF to ON, set Time-Lapse Power On in 0~255S.

To disable Auto Fan control setting, slide OFF to ON, Set Fan Speed at 0~100

Logout

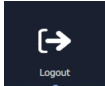
Click "Logout"  to exit the XPOSE software, and pop up window as follows:

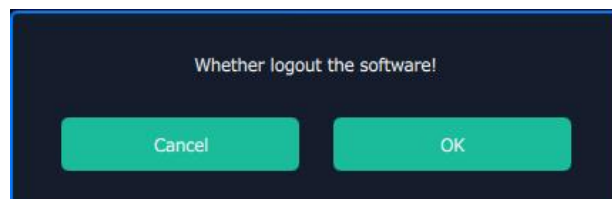

Click "cancel" or "OK" to confirm

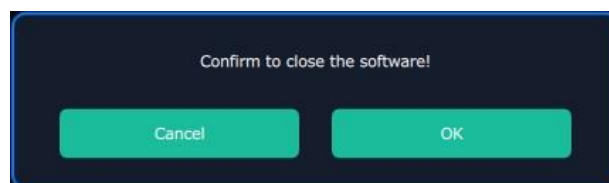

User also can be click the right corner  red button to exit software directly

Contact Information

Head Office:

Room 601A, No. 37-3 Banshang community, Building 3, Xinke Plaza, Torch Hi-Tech Industrial Development Zone, Xiamen, China

PH: +86-592-5771197

Fax: +86-592-5788216

E-mail: Support: support@rgblink.com
Sales: sales@rgblink.com

Web: Support: www.rgblink.com/support
Contact: www.rgblink.com/contact-us